

Series 88

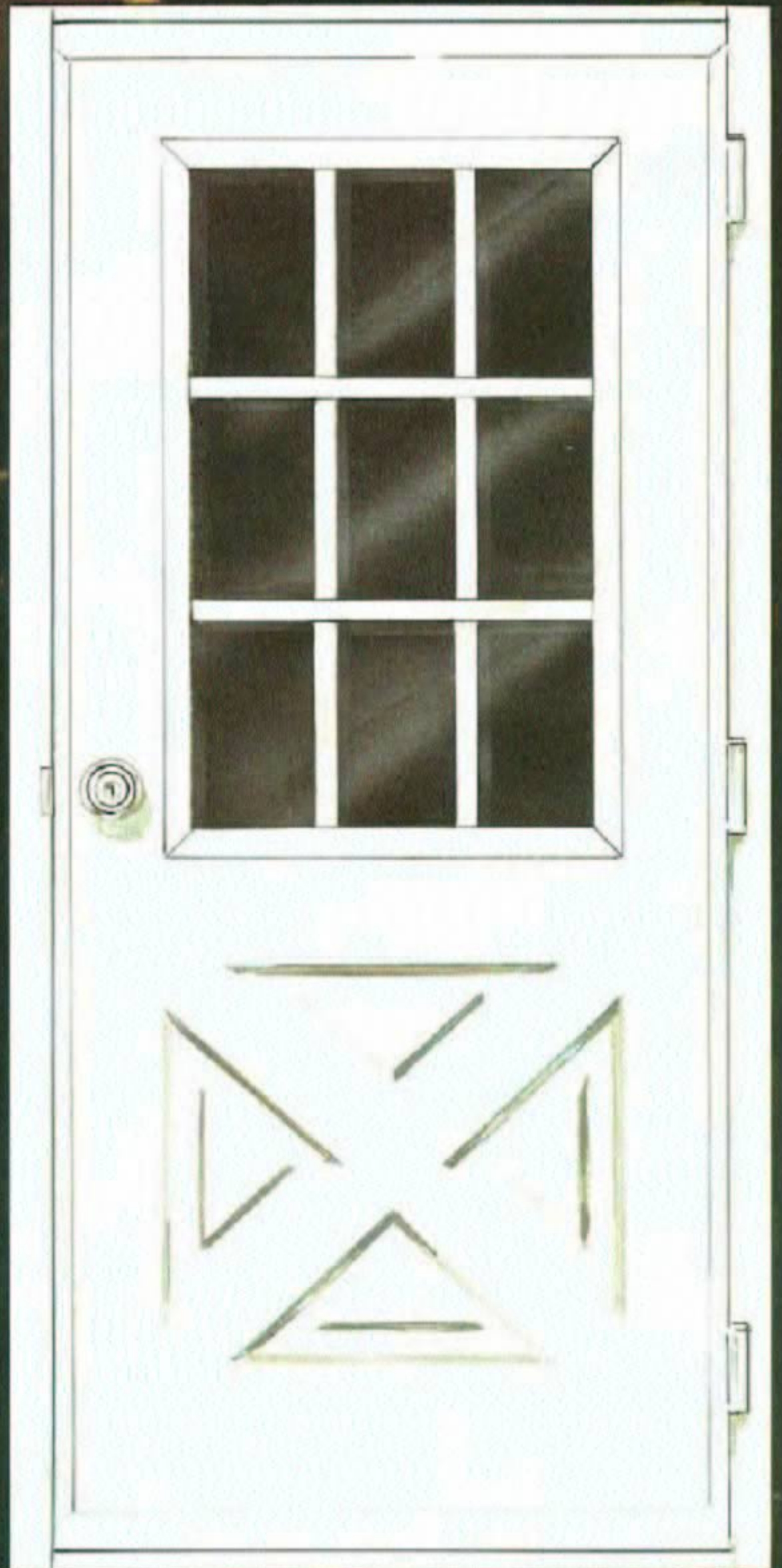

PLYCO

**HEAVY—DUTY
STEEL CLAD
SERVICE DOOR**



PLYCO

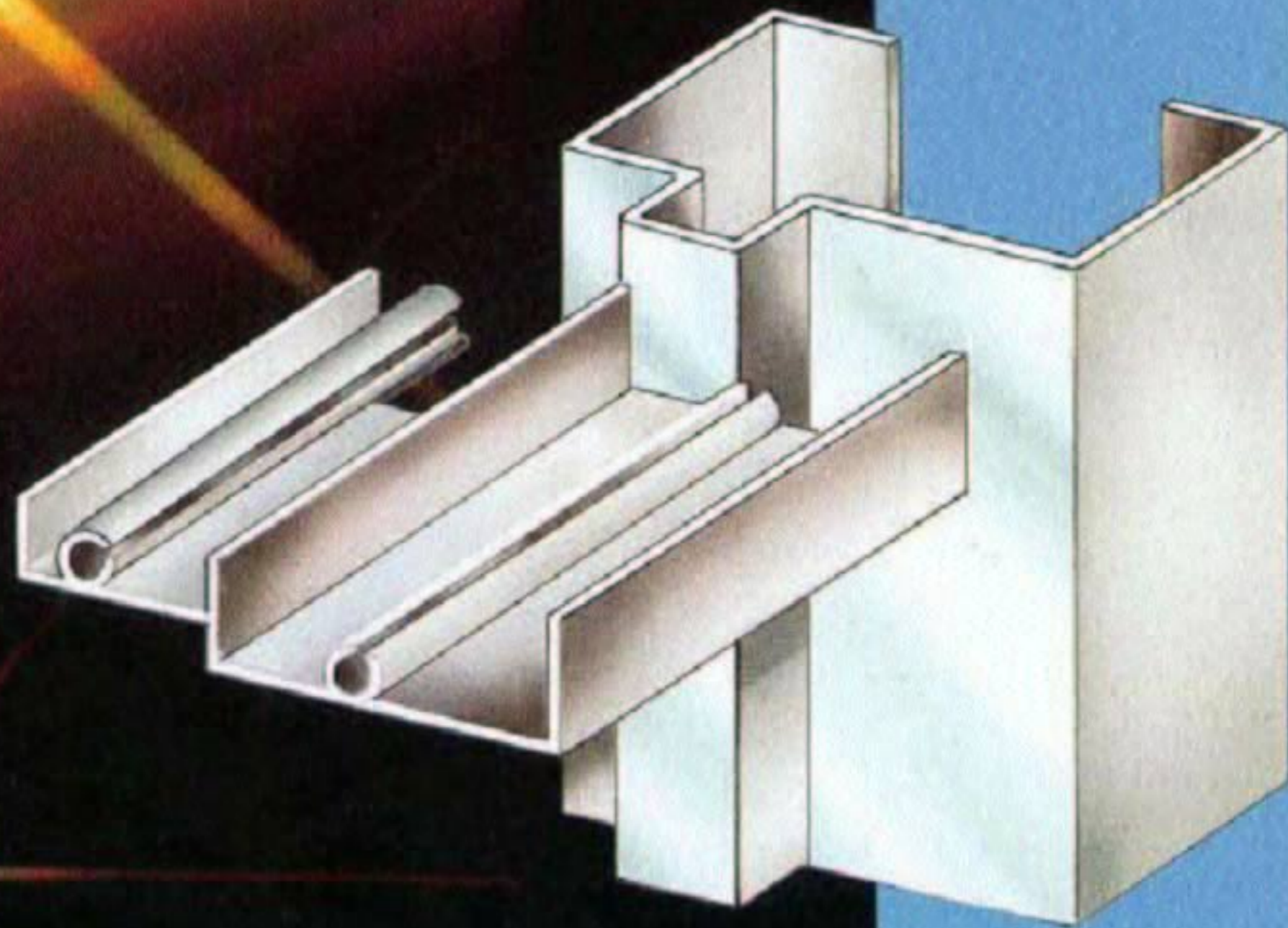

Everlast Quality Door Systems Provide:

- Low Maintenance
- Economy
- Attractive Appearance
- Ease of Installation
- Energy Saving
- Durability

**LITE OPTIONS
ALL UNITS WHITE OR BRONZE
ALUMINUM FRAMED**

**STANDARD
TEMPERED GLASS**



20" x 24"



4" x 48"

**WIRE
1/4" WIRE GLASS**



16" x 16"

**INSULATED
1" THERMO PANE**



22" x 36"



20" x 24"



22" x 36"
9 Lite



16" x 16"

**DECORATIVE CROSS BUCK
EMBOSSED - WHITE OR BRONZE**

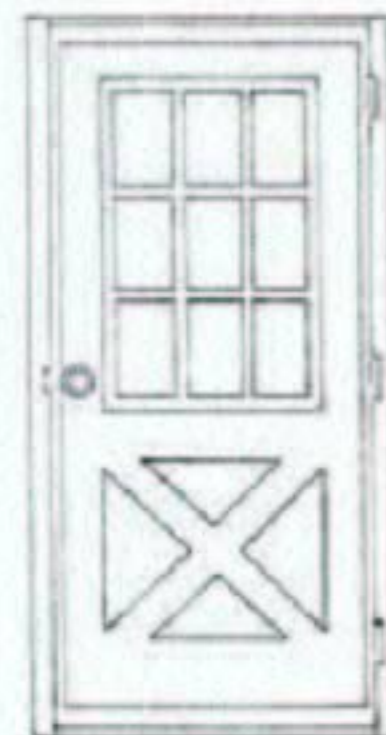

INSULATED SERVICE DOORS PRE-HUNG 4-WAY UNIVERSAL SWING

EVERLAST

**Prefinished Insulated
Door Systems**

Today's Service Door
Answer for Heavy-Duty
Construction Applications

Polyurethane Foam Core -
poured in place for superior
insulating quality - 11.53
R-Factor.

- 3½" Pre-Hung Frame System - 16 Gauge Pre-Painted Steel Verticals
- 4-Way Universal Swing
- White or Bronze Insulated Door Panels - 24 Gauge Baked Enamel Finish
- Individually Cartoned
- 3 Fixed Pinned Hinges
- 6'8" and 7'0" Heights Standard

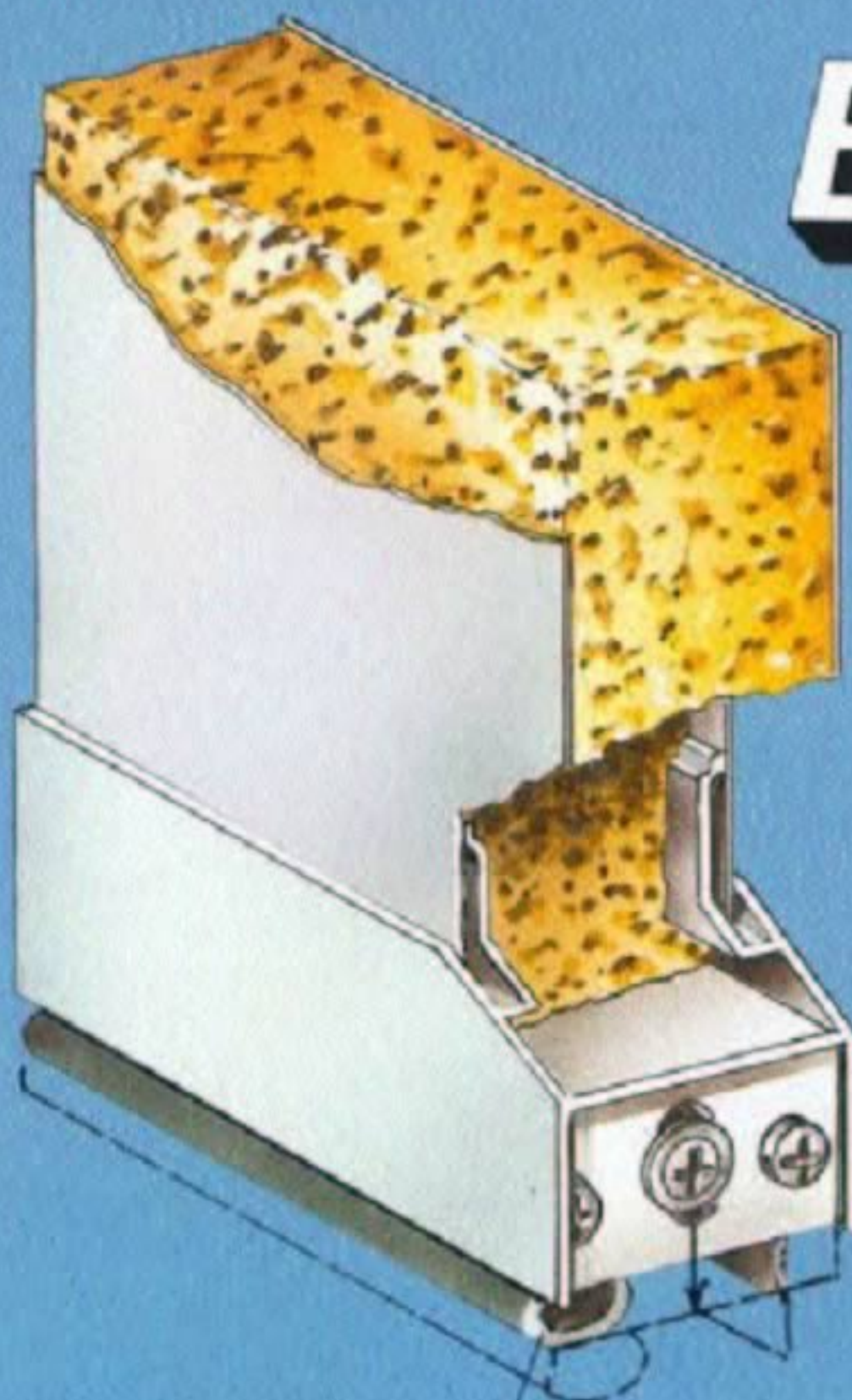

- Full Perimeter Adjustable Weatherstripping

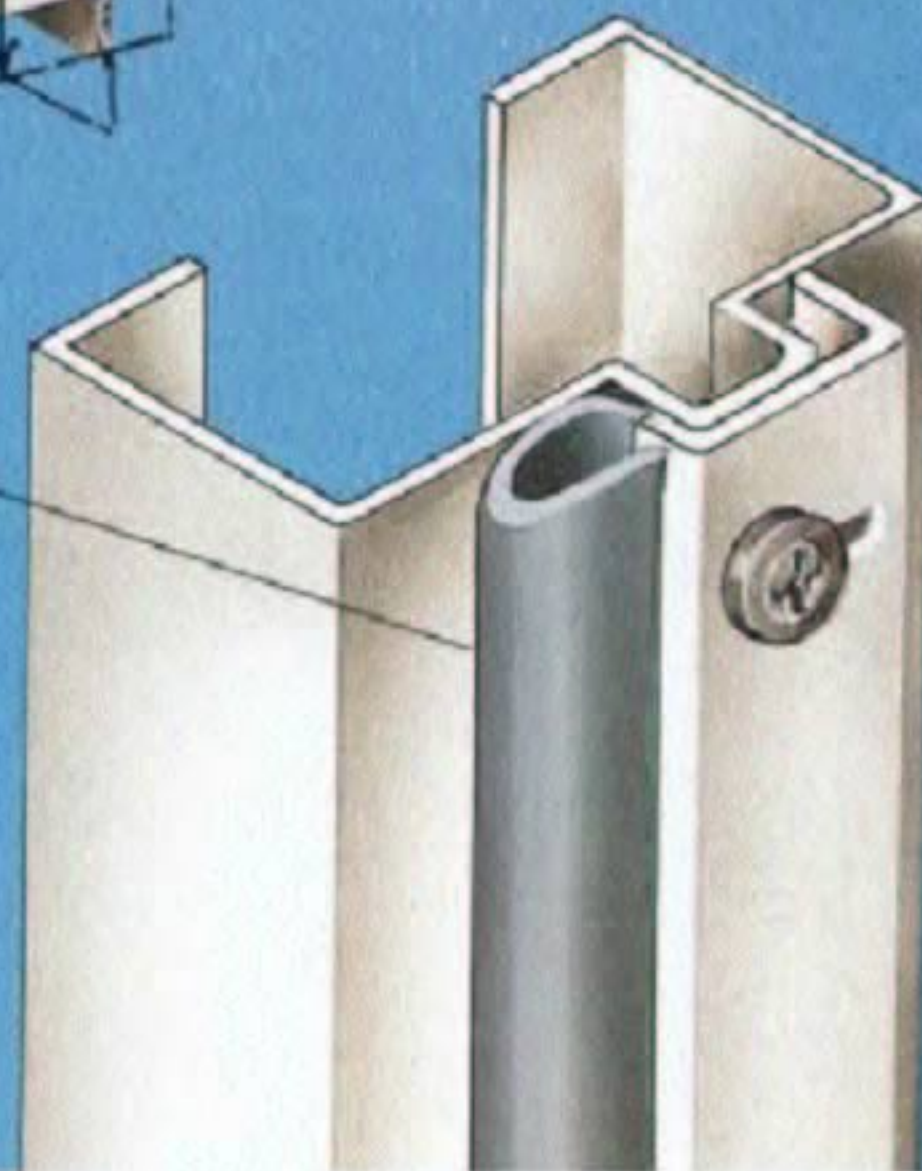

Basic unit consists of painted 16 gauge steel framed door with 24 gauge smooth steel panel, 3 fixed pinned hinges applied. Panel drilled to receive standard 2¾" backset w/face plate plunger style lockset. Door is complete with threshold and header. Units are individually cartoned with installation screws included.

Due to Plyco Corporation's on going commitment to product improvement, we reserve the right to change, without notice, product specifications, availability, prices and conditions of sale.

Products are shown with options, please contact your representative.

**S BUCK
R BRONZE**

**Series 88 Adapts to All Steel, Masonry, and
Wood Applications**

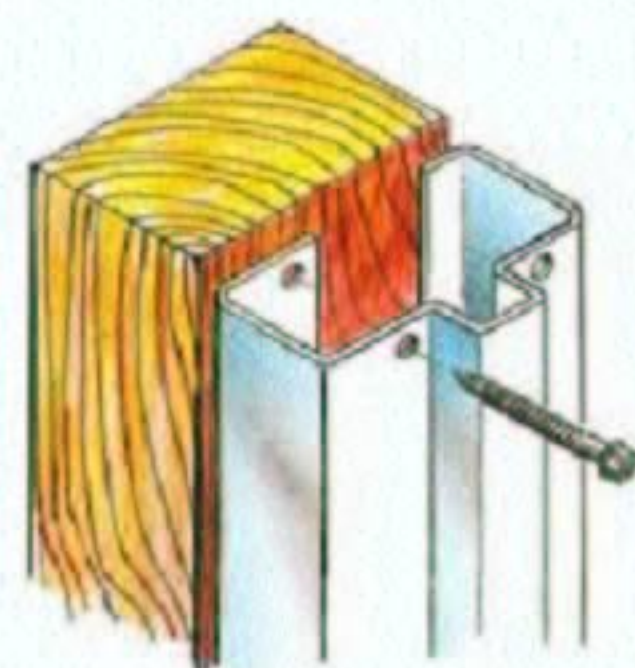
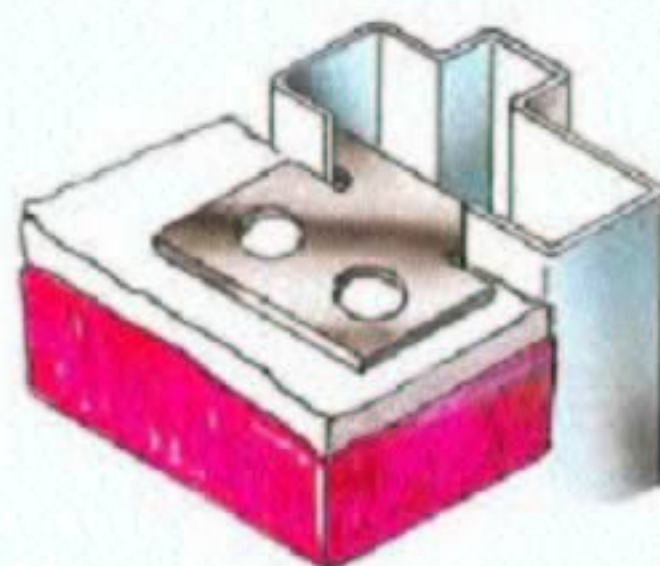
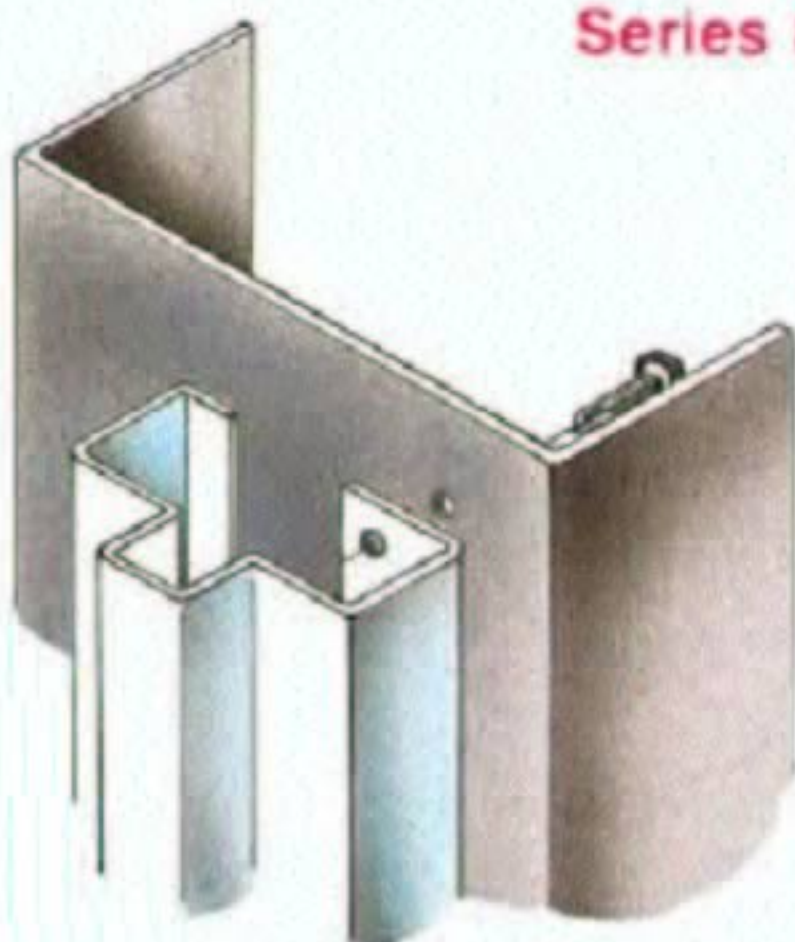

SPECIAL OPTIONS



LATCH GUARD

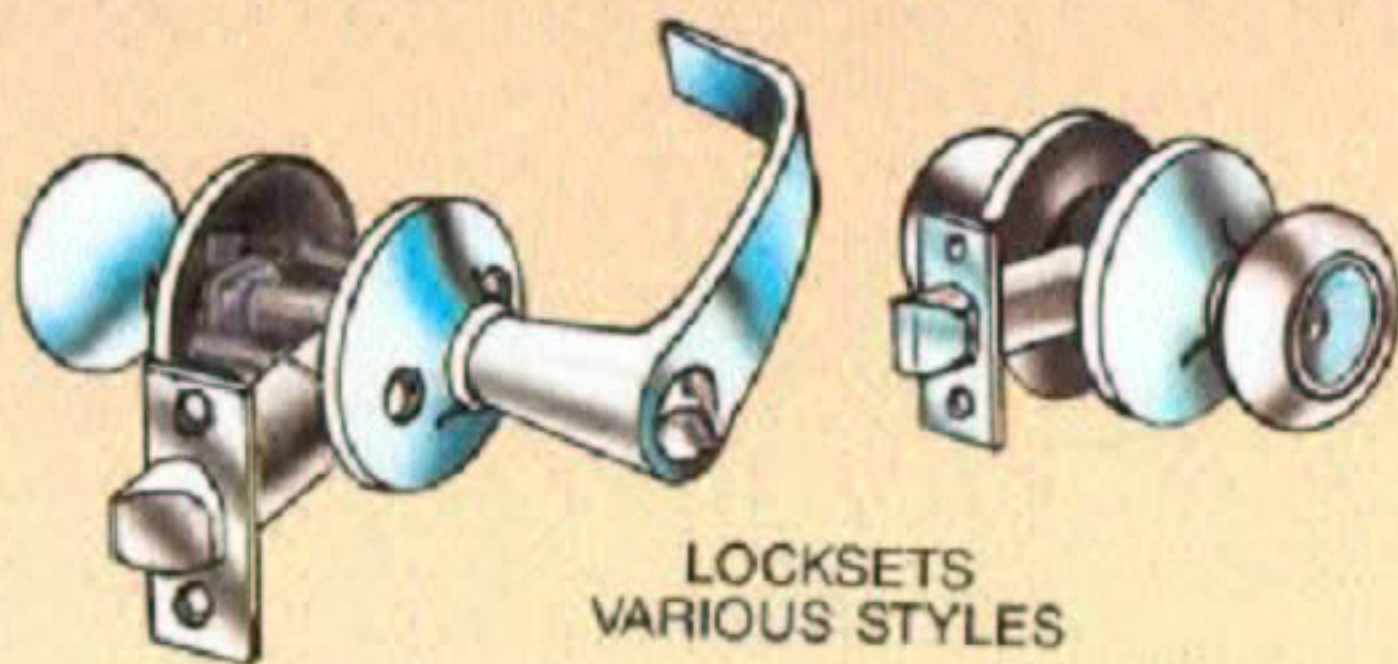

LOCKSETS
VARIOUS STYLES



KICK PLATES

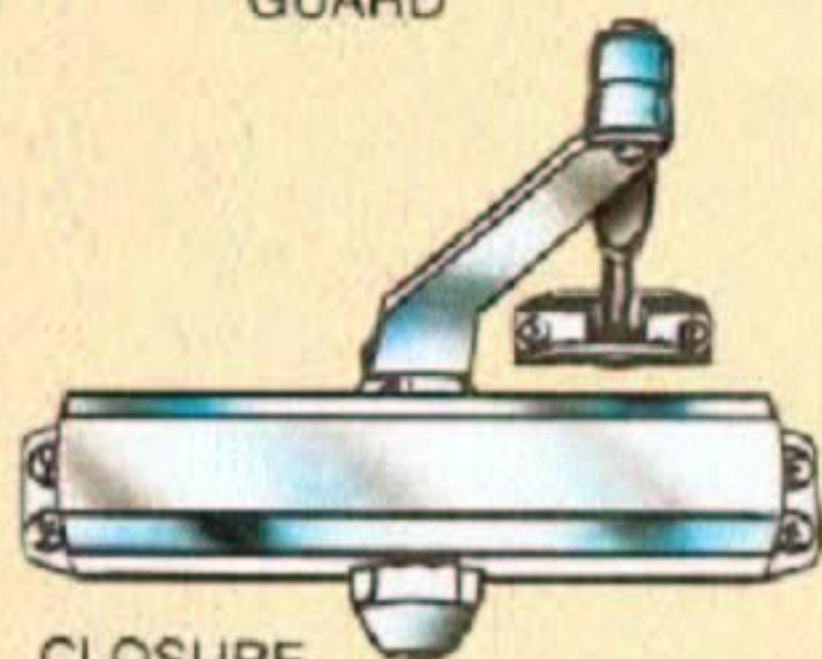

CLOSURE

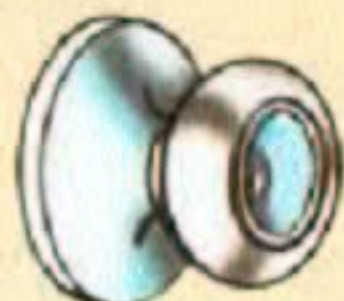

KNOB
LOCK

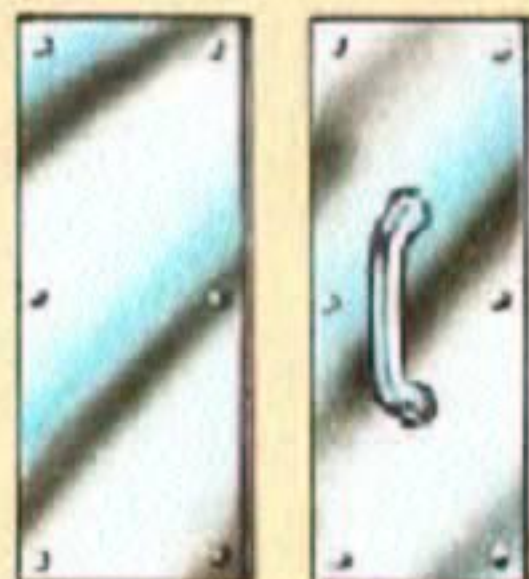

PUSH/PULL
PLATES

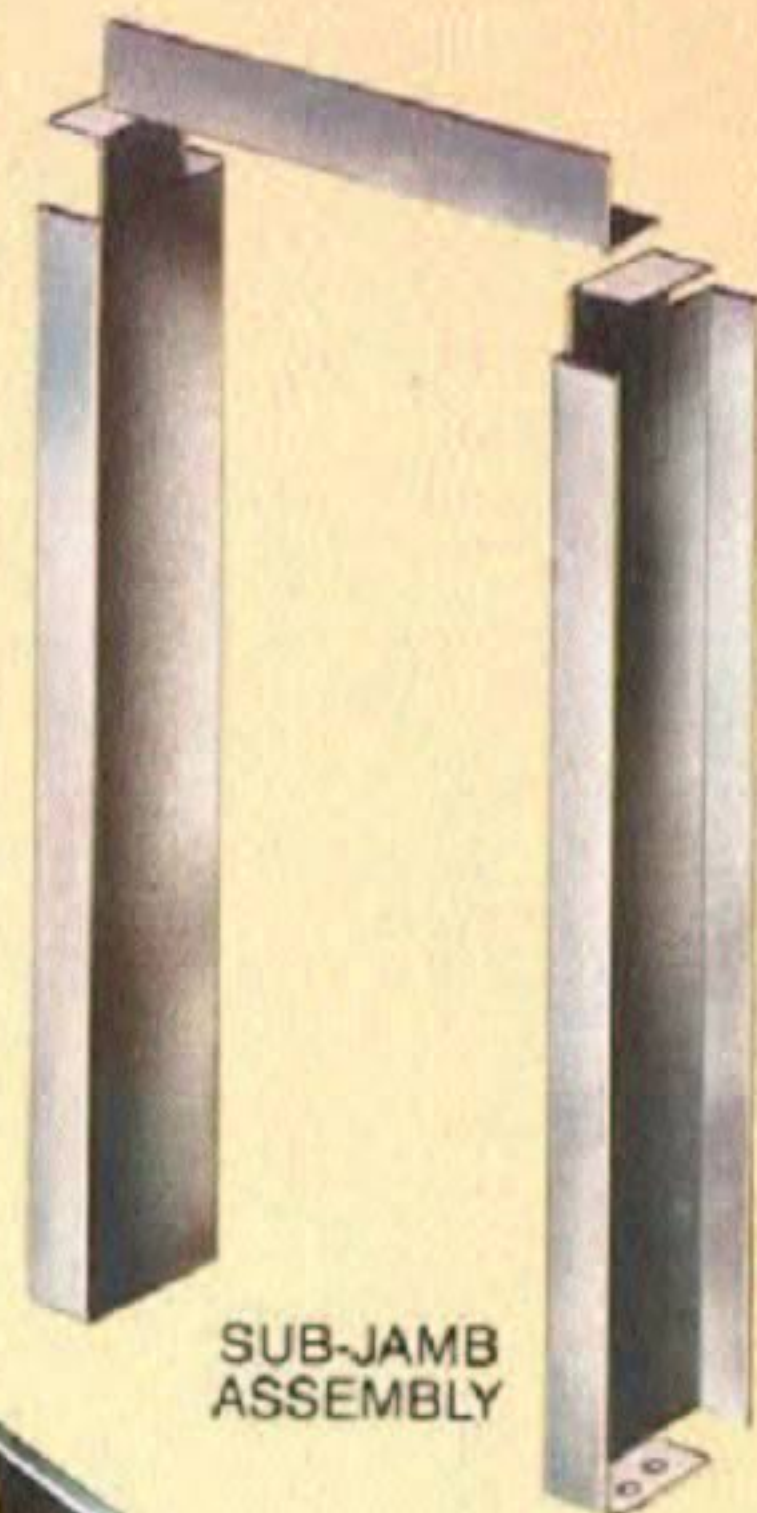

SUB-JAMB
ASSEMBLY

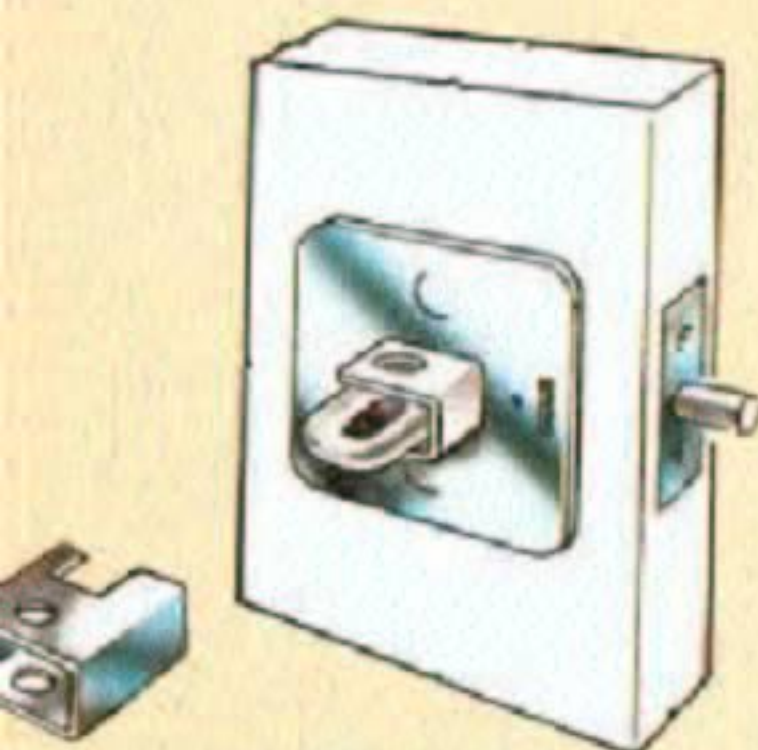

SELF-STORAGE
LOCK

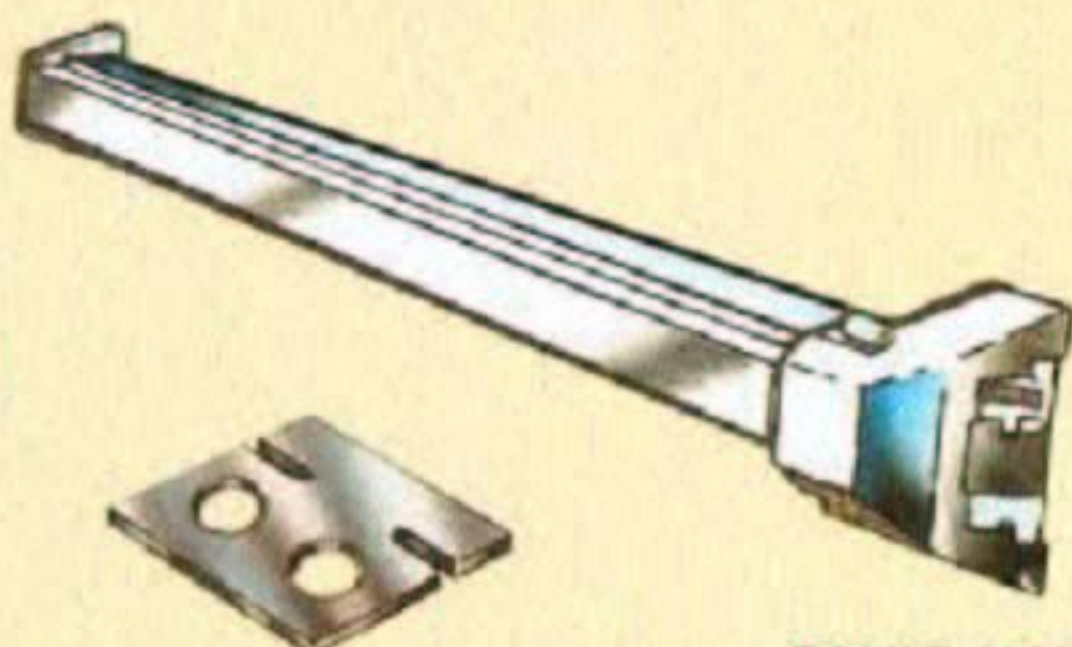

PANIC HARDWARE



MASONRY
CLIPS



MODULAR BLOCK
ALUMINUM HEADER

STANDARD DOOR SIZES

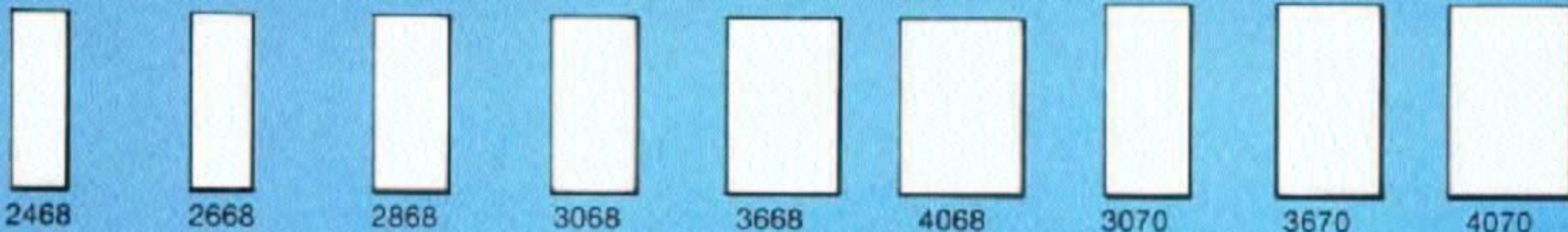

2468

2668

2868

3068

3668

4068

3070

3670

4070

Also Available - Full Line of Double & Special Size Doors

DISTRIBUTED BY

PLYCO
CORPORATION

Elkhart Lake, WI 53020

USA
800-558-5895
Fax 800-257-5926

INTERNATIONAL
920-876-3611
Fax 920-876-3527

NEW FROM

PLYCO

**16 GAUGE STEEL
SUB-FRAME PRE-ASSEMBLED
TO OUR 24 GAUGE STEEL
SERIES #88 DOOR**

Easy to Install

**16 Gauge
Galvanized
Sub-Frame,
8" Thick**

Saves Labor

**16 Gauge
Steel
Door Frame
3 1/2" Thick**

**Stainless Steel
Hinges**

**24 Gauge
Steel Door Panel,
Pre-finished,
Insulated**



**All Mounting
Clips Included!**

**Installation of Panic Hardware,
Closures and Locks is Available.**

Sizes 3070 & 4070

PLYCO
CORPORATION

Elkhart Lake, WI 53020

USA
800-558-5895
Fax 800-257-5926

INTERNATIONAL
920-876-3611
Fax 920-876-3527

699-2000JJ